

DDJN (External / Copying)

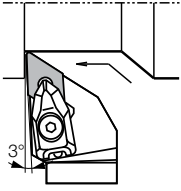

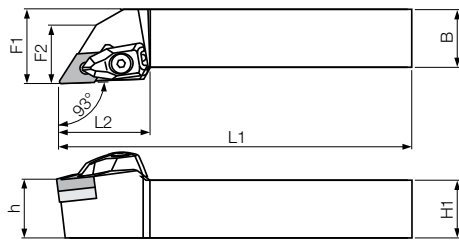

Side Rake Angle: -6°
Angle of Inclination: -7°

Applicable Inserts

Toolholder	Insert	
DDJN%L...-12-4B	DN□A	43..
	DN□G	
	DN□M	
DDJN%L...-16-4D	43..	
DDJN%L...-1504	DN□A	43.. (44..)
	DN□G	
	DN□M	44.. (43..)
DDJN%L...-1506	44.. (43..)	

• Right-hand shown

DDHN (External / Face Grooving / Copying)

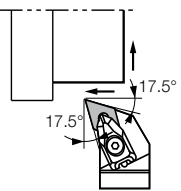

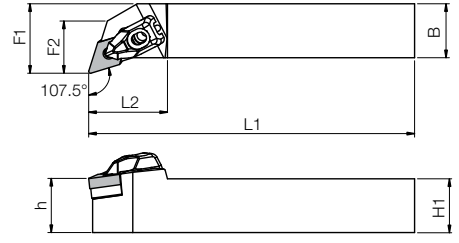











































Side Rake Angle: -6°
Angle of Inclination: -6°

Applicable Inserts

Toolholder	Insert	
DDHN%L...-1504	DN□A	43.. (44..)
	DN□G	
	DN□M	44.. (43..)
DDHN%L...-1506	44.. (43..)	

• Right-hand shown

Toolholder Dimensions

Part Number	Stock		Unit	Dimensions						Standard Corner-R(re)	Spare Parts						
	R	L		H1=h	B	L1	L2	F1	F2		Clamp	Screw	Spring	Shim	Shim Screw	Wrench	Wrench (Sold Separately)
																	
DDJN%L 12-4B 16-4D	●	●	Inch	0.75	0.75	4.50	1.54	1.00	-	1/32							
	○	○		1.00	1.00	6.00	1.54	1.25	0.97		CP-3D	CS-3D	SP-3D	DD-44 (DD-43)	SB-4085TR	LW-3	FT-15
DDJN%L 2020K-1504 2525M-1504	○	○	mm	20	20	125	39	25	-	0.8							
	○	○		25	25	150	39	32	25		CP-3D	CS-3D	SP-3D	*DD-44 (DD-43)	SB-4085TR	LW-3	FT-15
DDJN%L 2020K-1506 2525M-1506	●	○	mm	20	20	125	39	25	-	0.8							
	●	●		25	25	150	39	32	25		CP-3D	CS-3D	SP-3D	DD-43 (*DD-44)	SB-4085TR	LW-3	FT-15
DDHN%L 2020K-1504 2525M-1504	○	○	mm	20	20	125	37	25	22	0.8							
	○	○		25	25	150	37	32	22		CP-3D	CS-3D	SP-3D	*DD-44 (DD-43)	SB-4085TR	LW-3	FT-15
DDHN%L 2020K-1506 2525M-1506	○	○	mm	20	20	125	37	25	22	0.8							
	○	○		25	25	150	37	32	22		CP-3D	CS-3D	SP-3D	DD-43 (*DD-44)	SB-4085TR	LW-3	FT-15

Shims indicated within () are not included with the toolholder. To change insert thickness, please purchase it separately.

* When using inserts whose corner-R(re) is greater than 1/16", additional modifications of the shim are necessary in order to prevent workpiece and shim from interfering with each other.

MDJN (External / Copying)

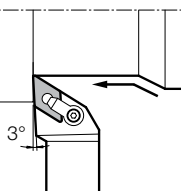

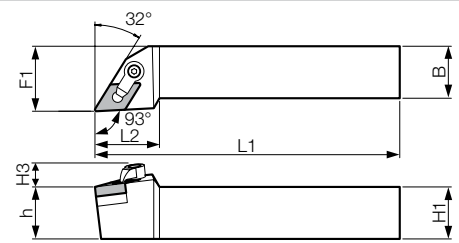















Side Rake Angle: -6°
Angle of Inclination: -6°

Applicable Inserts

Toolholder	Insert	
MDJN%L...-12-4B	DN□A	43..
	DN□G	
	DN□M	
MDJN%L...-16-4D	43..	

• Right-hand shown

Toolholder Dimensions

Part Number	Stock			Unit	Dimensions						Standard Corner-R(re)	Spare Parts						
	R	L	N		H1=h	H3	B	L1	L2	F1		Clamp	Clamp Screw	Wrench	Shim	Shim Screw	Lock Pin	Wrench
																		
MDJN%L 12-4B 16-4D	●	●		Inch	0.75	0.47	0.75	4.50	1.25	1.00	1/32							
	●	●			1.00	0.46	1.00	6.00	1.25	1.25		CL-20	XNS-48	LW-125	IDSN443	S-46	NL46	LW-094